



SPARE PARTS EXPLODED VIEW
OIL BURNER
Model
CB-VE1(A)

R8220008-04 - 21/08/2019

CB-VE1(A)

Oil burner

1	3832629	CB-VE 1.34	12-2008	-
2	3832630	CB-VE 1.34	12-2008	-
3	3835893	CB-VE1.34 A	11-2016	-
4	3832631	CB-VE 1.35	12-2008	-
5	3832632	CB-VE 1.50	12-2008	-
6	3832633	CB-VE1.52	12-2008	03-2017
7	3835894	CB-VE1.52 A	11-2016	-
8	3832634	CB-VE 1.75	12-2008	-
Col	Reference	Model type	Begin	End

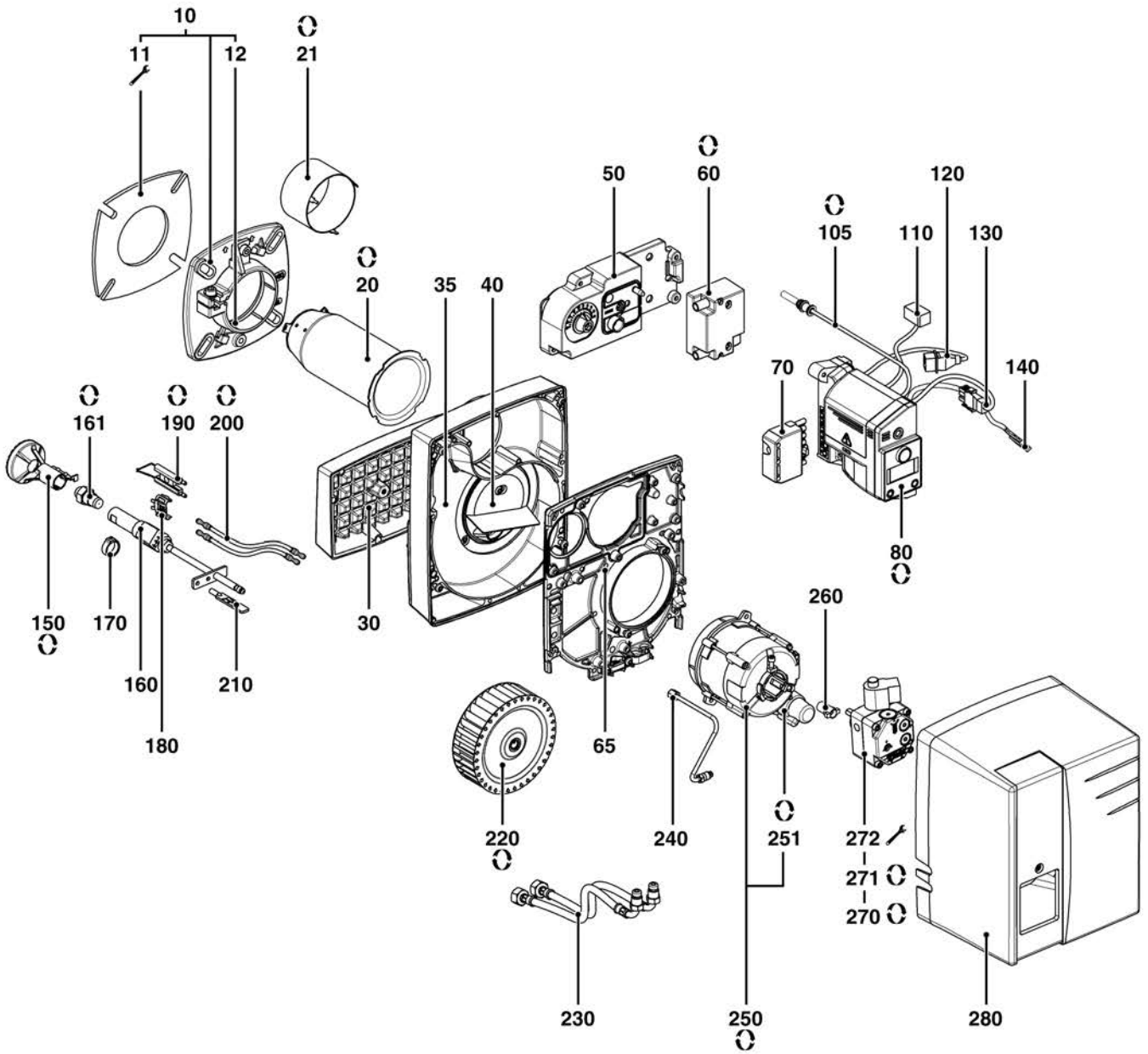

5000

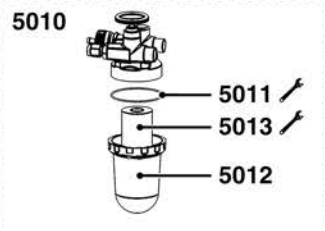
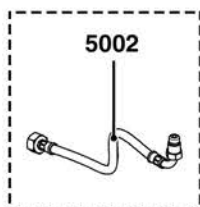
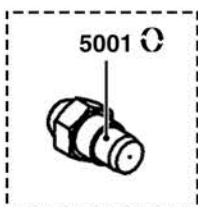

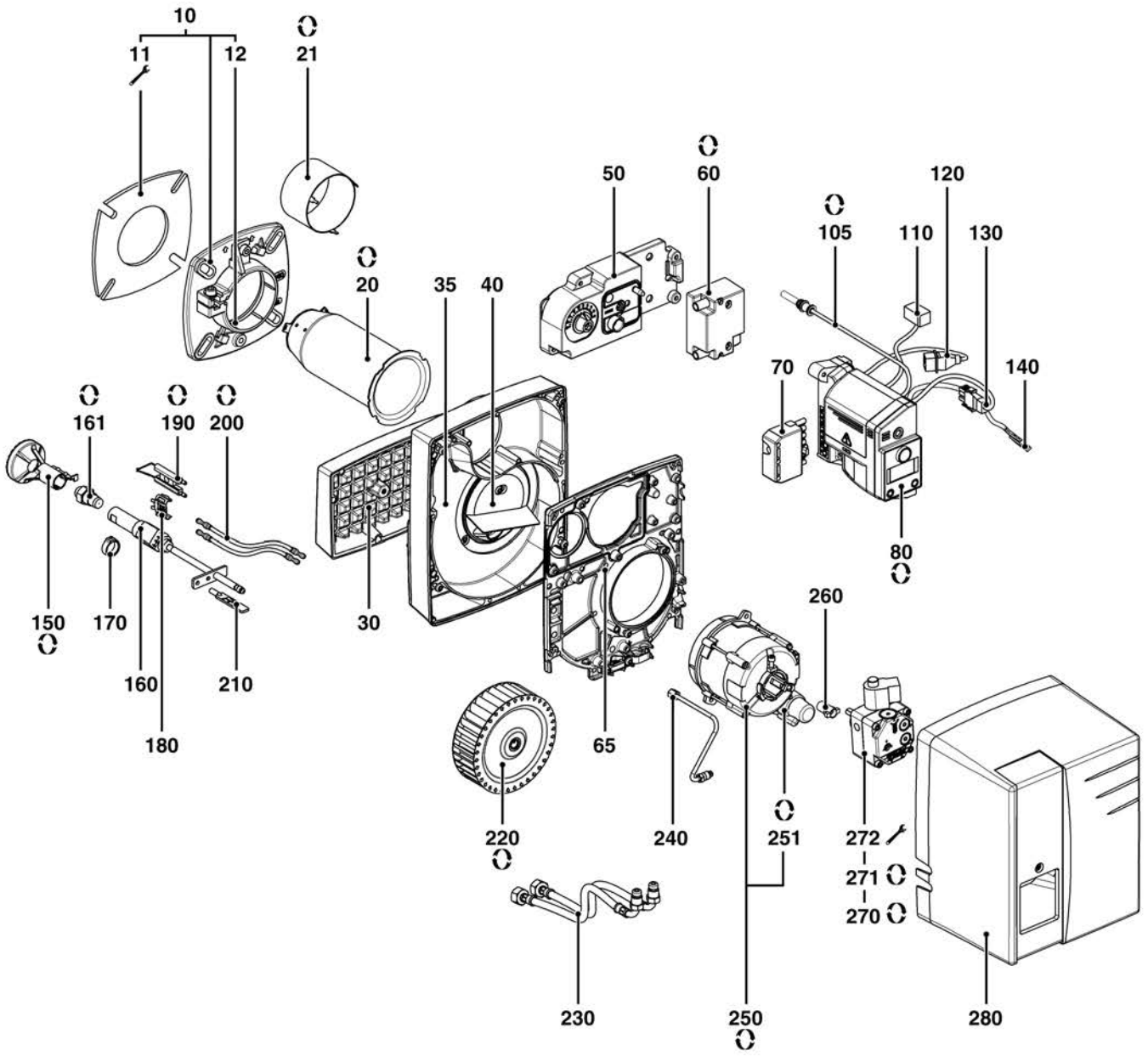

5000

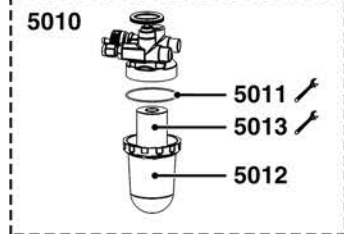
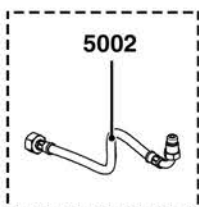
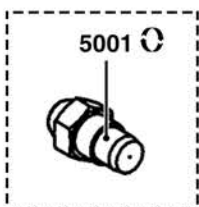

			DE	FR	IT	
			NL	ES		
0010	13018849	ANSCHLUSSFLANSCH D90 EUROFLANSCH BEVESTIGINGSSET KETEL D90 EUROFLENS	ACCESORE CHAUDIERE D90 EUROBRIDE ACCESORIO CALDERA D90 EUROBRIDA	ACCESSORIO CALDAIA D90 EUROFLANGIA	1	
	13022754	ANSCHLUSSFLANSCH D80 EUROFLANSCH MONTAGEFLENS+PAKKING D80 EUROFLENS	ACCESORE CHAUDIERE D80 EUROBRIDE ACCESORIO CALDERA D80 EUROBRIDA	ACCESSORIO CALDAIA D80 EUROFLANGIA	1	
0011	13010501	DICHTUNG/BRENNERFLANSCH 156X156X6 D80 PAKKING/OPHANGFLENS 156X156X6 D80	JOINT/BRIDE BRULEUR 156X156X6 D80 JUNTA/BRIDA QUEMADOR 156X156X6 D80	GUARNIZIONE/FLANGIA BRUC. 156X156X6 D80	1	
	13010502	DICHTUNG/BRENNERFLANSCH 156X156X5 D90 PAKKING/OPHANGFLENS 156X156X5 D90	JOINT/BRIDE BRULEUR 156X156X5 D90 JUNTA/BRIDA QUEMADOR 156X156X5 D90	GUARNIZIONE/FLANGIA BRUC. 156X156X5 D90	1	
0012	13011148	DICHTSCHNUR D80X5X5-267 PAKKING/GEVLOCHTE D80X5X5-267	JOINT/TRESSE D80X5X5-267 JUNTA/TRENZADA D80X5X5-267	GUARNIZIONE/TRECCIA D80X5X5-267	1	
	13011149	DICHTSCHNUR D90X5X5-298 PAKKING/GEVLOCHTE D90X5X5-298	JOINT/TRESSE D90X5X5-298 JUNTA/TRENZADA D90X5X5-298	GUARNIZIONE/TRECCIA D90X5X5-298	1	
0020	13010099	BRENNERROHR D80/54 L183 BRANDERBUIS D80/54 L183	TUBE DE FLAMME D80/54 L183 TUBO DE LLAMA D80/54 L183	BOCCAGLIO D80/54 L183	1	
	13011142	BRENNERROHR D90/64,5/60 L198 BRANDERBUIS D90/64,5/60 L198	TUBE DE FLAMME D90/64,5/60 L198 TUBO DE LLAMA D90/64,5/60 L198	BOCCAGLIO D90/64,5/60 L198	1	
	13012815	BRENNERROHR D80/57 L183 BRANDERBUIS D80/57 L183	TUBE DE FLAMME D80/57 L183 TUBO DE LLAMA D80/57 L183	BOCCAGLIO D80/57 L183	1	
0021	13006487	FLAMMENTOPF D79 L50 FP617 VOORZETBUIS D79 L50 FP617	EMBOUT AVANT D79 L50 FP617 COPA DE COMBUSTION D79 L50 FP617	CAMPANA D79 L50 FP617	1	
	13015244	FLAMMENTOPF D84,5 L50 VOORZETBUIS D84,5 L50	EMBOUT AVANT D84,5 L50 COPA DE COMBUSTION D84,5 L50	CAMPANA D84,5 L50	1	
0030	13018434	LUFTKASTEN 218X135X45 LUCHTKAST 218X135X45	BOITE A AIR 218X135X45 CAJA DE AIRE 218X135X45	CASSA ASPIR. ARIA 218X135X45	1	
	65300231	LUFTKASTEN 218X134+ ISOLIERUNG LUCHTAANZUIJKAST 218X134+ ISOLATIE	BOITE A AIR 218X134+ ISOLATION CAJA DE AIRE 218X134+ AISLAMIENTO	CASSA ASPIR. ARIA 218X134+ ISOLAZIONE	1	
0035	65300460	GEHÄUSE 227X224X45 D80 NC4-6H/VL1.40-55 BRANDERHUIS 227X224X45D80 NC4H/VL1.40-55	CARTER 227X224X45 D80 NC4-6H/VL1.40-55 CÁRTER 227X224X45 D80 NC4-6H/VL1.40-55	FUSIONE 227X224X45 D80 NC4-6H/VL1.40-55	1	
	65327970	GEHÄUSE 227X224X68 D90 NC9-10H/VLL1.105 BRANDERHUIS 227X224X68 D90 NC10H/VL1.105	CARTER 227X224X68 D90 NC9-10H/VL1.95-105 CÁRTER 227X224X68 D90 NC9-10H/VL1.95-105	FUSIONE 227X224X68D90 NC9-10H/VL1.95-105	1	
0040	13010511	ANSAUGLUFTFUEHRUNG D103/35 80X68L39 108° LUCHTGELEIDING D103/35 VIN80X68 L39 108°	RECYCLAGE AIR D103/35 AL.80X68 L39 108° RECICLAJE AIRE D103/35 AL.80X68 L39 108°	CONVOGLIAT.ARIA D103/35 80X68 L39 108°	1	
	13010512	ANSAUGLUFTFUEHRUNG D103/35 100X95 L39 LUCHTGELEIDING D103/35 100X95 L39 108°	RECYCLAGE AIR D103/35 100X95 L39 108° RECICLAJE AIRE D103/35 100X95 L39 108°	CONVOGLIAT.ARIA D103/35 100X95 L39 108°	1	
	13010513	ANSAUGLUFTFUEHRUNG D103/45 100X97L55 65° LUCHTGELEIDING D103/45 VIN100X97 L55 65°	RECYCLAGE AIR D103/45 AL.100X97 L55 65° RECICLAJE AIRE D103/45 100X97 L55 65°	CONVOGLIATORE ARIA D103/45 100X97L55 65°	1	
0050	13010472	ANTRIEBKASTEN KLASPE BG+ FOTOZELL ROHR/ÖL LUCHTSTURINGSEENHEID	BOITIER COM.VOLET ASS.+TUBE CELL./FIOUL CAJA MANDOS VALV. ASS.+TUBERIA CELL/OLEO	SCATOLA COMM.SERR. ASS.+TUBO CELL./OLIO	1	
0060	13009663	ZUENDTRAFO EBI 2X7,5 230V ONTSTEKINGSTRAFO EBI 2X7,5 230V	ALLUMEUR EBI 2X7,5 230V ENCENDEDOR EBI 2X7,5 230V	TRASFO. ACC. EBI 2X7,5 230V+PRESA TERRA	1	
0065	13020416	MOTORPLATTE 275X222X23 D99+O-RING MOTORPLAAT 275X222X23 D99+O-RING	PLATINE MOTEUR 275X222X23 D99+O-RING PLACA MOTOR 275X222X23 D99+O-RING	PIASTRA MOTORE 275X222X23 D99+O-RING	1	
0070	13010523	STECKER WIELAND 7P SIEBGEDRUCKTEN CONTACTSTOP WIELAND 7P GEZEEDRUKTE	PRISE MALE WIELAND 7P SERIGRAPHIE TOMA WIELAND 7P SERIGRAFIADO	SPINA WIELAND 7P SERIGRAFATO	1	
0080	65300269	FEUERUNGSAUTOMAT TCH 141.03 BRANDERAUTOMAAT TCH 141.03	COFFRET TCH 141.03 PROGRAMADOR TCH 141.03	APPARECCHIATURA TCH 141.03	1	
	65326871	FEUERUNGSAUTOMAT TCH 151.12 BRANDERAUTOMAAT TCH 151.12	COFFRET TCH 151.12 PROGRAMADOR TCH 151.12	APPARECCHIATURA TCH 151.12	1	
0105	65326635	FOTOZELLE QRB1A LG.220+RAST5 FOTOCEL QRB1A LG.220+RAST5	CELLULE QRB1A LG.220+RAST5 CELULA QRB1A LG.220+RAST5	FOTOCCELLULA QRB1A LG.220+RAST5	1	
	65328028	FOTOZELLE FTEB3 L255+RAST5 FOTOCEL FTEB3 L255+RAST5	CELLULE FTEB3 L255+RAST5 CELULA FTEB3 L255+RAST5	FOTOCCELLULA FTEB3 L255+RAST5	1	
0110	65300335	KABEL ZÜNDTRAFO+STCK 3P/RAST3P L250 ONTSTEKINGSTRAFOKABEL+STCK3P/RAST3P L250	CABLE ALLUMEUR+PRISE 3P/RAST3P L250 CABLE ENCENDEDOR+TOMA 3P/RAST3P L250	CAVO TRASFO ACCENS.+PRESA 3P/RAST3P L250	1	
0120	13012675	KABEL ÖLVENTIL+STCK 3P/RAST3P L300V1 KABEL MAGNEETKLEP+STCK.3P/RAST3P L300V1	CABLE EL.VANNE+PRISE 3P/RAST3P L300V1 CABLE EL.VALVULA+TOMA 3P/RAST3P L300V1	CAVO EL.VALVOLA+PRESA 3P/RAST3P L300V1	1	
0130	13010519	KABEL MOTOR+STECKER 3P/RAST3P L300 KABEL MOTOR+STCK3P/RAST3P L300	CABLE MOTEUR+PRISE 3P/RAST3P L300 CABLE MOTOR+TOMA 3P/RAST3P L300	CAVO MOTORE+PRESA 3P/RAST3P L300	1	
0140	13011126	KABEL VORHITZER DAN+STCK 4P/RAST4P L450 VORWARM.KABEL DAN+STEKKER 4P/RAST4P L450	CABLE RECHAUFF. DAN+PRISE 4P/RAST4P L450 CABLE CALENTADOR DAN+TOMA 4P/RAST4P L450	CAVO PRERISCAL.DAN+PRESA 4P/RAST4P L450	1	
0150	13006486	STAUSCHEIBE D55/17 4SL R STUWPLAAT D55/17 4SL R	DEFLECTEUR D55/17 4SL R DEFLECTOR D55/17 4SL R	DIFFUSORE D55/17 4SL R	1	
	13012730	STAUSCHEIBE D63/18 6SL R STUWPLAAT D63/18 6SL R	DEFLECTEUR D63/18 6SL R DEFLECTOR D63/18 6SL R	DIFFUSORE D63/18 6SL R	1	
0160	13012680	DÜSENSTANGE D8 L252 M8 HITZER FPHE 5-LE SPROEIERLIJNE D8 L252 M8 WARM.FPHE 5-LE	LIGNE GICLEUR D8 L252 M8 RECH.FPHE 5-LE LÍNEA BOQU. D8 L252 M8 CALENT. FPHE 5-LE	LINEA UGELLO D8 L252 M8 RISCAL.FPHE 5-LE	1	
	13018521	DÜSENSTANGE D8 L272 M8 FPB-LE SPROEIERLIJNE D8 L272 M8 FPB-LE	LIGNE GICLEUR D8 L272 M8 FPB-LE LÍNEA DE BOQUILLA D8 L272 M8 FPB-LE	LINEA UGELLO D8 L272 M8 FPB-LE	1	
	13018567	DÜSENSTANGE D8 L252 M8 FPB-LE SPROEIERLIJNE D8 L252 M8 FPB-LE	LIGNE GICLEUR D8 L252 M8 FPB-LE LÍNEA DE BOQUILLA D8 L252 M8 FPB-LE	LINEA UGELLO D8 L252 M8 FPB-LE	1	
0161	11002536	DUESE DAN 0,45GPH 45° HFD NOZZLE DAN 0,45GPH 45° HFD	GICLEUR DAN 0,45GPH 45° HFD BOQUILLA DAN 0,45GPH 45° HFD	UGELLO DAN 0,45GPH 45° HFD	1	

		DE		FR		IT		
		NL		ES				
	13016061	DUESE DAN 0,75GPH 45° S NOZZLE DAN 0,75GPH 45° S		GICLEUR DAN 0,75GPH 45° S BOQUILLA DAN 0,75GPH 45° S		UGELLO DAN 0,75GPH 45° S		1
	13016064	DUESE DAN 0,60GPH 45° S NOZZLE DAN 0,60GPH 45° S		GICLEUR DAN 0,60GPH 45° S BOQUILLA DAN 0,60GPH 45° S		UGELLO DAN 0,60GPH 45° S		1
	13018576	DUESE DAN 0,55GPH 45° S SPROEIER DAN 0,55GPH 45° S		GICLEUR DAN 0,55GPH 45° S BOQUILLA DAN 0,55GPH 45° S		UGELLO DAN 0,55GPH 45° S		1
	65300496	DUESE DAN 0,45GPH 45° S NOZZLE DAN 0,45GPH 45° S		GICLEUR DAN 0,45GPH 45° S BOQUILLA DAN 0,45GPH 45° S		UGELLO DAN 0,45GPH 45° S		1
	65323348	DUESE DAN 1,10GPH 45° H SPROEIER DAN 1,10GPH 45° H		GICLEUR DAN 1,10GPH 45° H BOQUILLA DAN 1,10GPH 45° H		UGELLO DAN 1,10GPH 45° H		10
0170	13018403	EINSTELLRING D25/19X3/DUESE-STAUICHEIBE INSTELRING D25/19X3/SPOEIER-STUWPLAAT		BAGUE D'ARRET D25/19X3/GICL.-DEFLECT. ANILLO DE TOPE D25/19X3/BOQU.-DEFLECT.		BOCCOLA DI FERMO D25/19X3/UGELLO-DIFFU.		1
0180	13011138	FLANSCH 22X20X7 FIX. ZUENDELEKTRODE FLENS 22X20X7 FIX. ONTSTEKINGSPEN		BRIDE 22X20X7 FIX. ELECTRODE BRIDA 22X20X7 FIX. ELECTRODO		FLANGIA 22X20X7 FIX. ELETTRODO		1
0190	65300270	ZUENDELEKTRODENBLOCK 25X46 d4D1,5X21 56° ELEKTRODENBLOK 25X46 d4D1,5X21 56°		BLOC-ELECTRODES 25X46 d4D1,5X21 56° BLOQUE ELECTRODOS 25X46 d4D1,5X21 56°		BLOCCO ELETTRODI 25X46 d4D1,5X21 56°		1
0200	13011123	ZÜNDKABEL D4/D4 L270X2 + TUELLE ONTSTEKINGSKABEL D4/D4 L270X2+DRAADDOOR.		CABLE ALLUMAGE D4/D4 L270X2 +PASSE-CABLE CABLE ENCENDIDO D4/D4 L270X2 +PASSACABLE		CAVO ACCENSIONE D4/D4 L270X2 + PASSACAVO		1
0210	13010100	EINSTELLSKALA 0 - 20 L70,5 INSTELLING SCHAAL 0 - 20 L70,5		REGLETTE GRADUEE 0 - 20 L70,5 REGLETA GRADUADA 0 - 20 L70,5		SCALA GRADUATA 0 - 20 L70,5		1
0220	13010101	VENTILATORRAD D133X42 D10 VENTILATORWIEL D133X42 D10		TURBINE D133X42 D10 TURBINA D133X42 D10		VENTOLA D133X42 D10		1
	13010517	VENTILATORRAD D133X62 D10 VENTILATORWIEL D133X62 D10		TURBINE D133X62 D10 TURBINA D133X62 D10		VENTOLA D133X62 D10		1
0230	12002251	OELSCHLAUCH L 1500 DN6 G3/8G1/4A OLIESLANG L 1500 DN6 G3/8G1/4A		FLEXIBLE FIOUL L 1500 DN6 G3/8-G1/4A LATIGUILLO L 1500 DN6 G3/8G1/4A		FLESSIBILE GASOLIO L1500 DN6 G3/8G1/4A		1
0240	13021624	CU-ROHR PUMPE/D-STANGE TOEVOERLEIDING SPROEIER		TUBE POMPE/LIGNE GICLEUR TUBO BOMBA/LINEA DE BOQUILLA		TUBETTO POMPA/LINEA UGELLO		1
0250	65326746	MOTOR 0,11KW 230V D10 MOTOR 0,11KW 230V D10		MOTEUR 0,11KW 230V D10 MOTOR 0,11KW 230V D10		MOTORE 0,11KW 230V D10		1
0251	13010016	KONDENSATOR 6,3µF 2P 3mm CONDENSATOR 6,3µF 2P 3mm		CONDENSATEUR 6,3µF 2P 3mm CONDENSADOR 6,3µF 2P 3mm		CONDENSATORE 6,3µF 2P 3mm		1
	13011117	KONDENSATOR 4µF 2P 3mm KONDENSATOR 4µF 2P 3mm		CONDENSATEUR 4µF 2P 3mm CONDENSADOR 4µF 2P 3mm		CONDENSATORE 4µF 2P 3mm		1
	65326737	KONDENSATOR 5µF 475V B P2 30X57 CONDENSATOR 5µF 475V B P2 30X57		CONDENSATEUR 5µF 475V B P2 30X57 CONDENSADOR 5µF 475V B P2 30X57		CONDENSATORE 5µF 475V B P2 30X57		1
0260	65074172	KUPPLUNG D18/14,7/11X22 PUMPE/MOTOR KOPPELING D18/14,7/11X22 POMP/MOTOR		ACCOUPLMENT D18/14,7/11X22 POMPE/MOTEUR ACOPLAMIENTO D18/14,7/11X22 BOMBA/MOTOR		GIUNTO D18/14,7/11X22 POMPA/MOTORE		1
0270	13022753	OELPUMPE BFP 21 L3 LES R2 POMP BFP 21 L3 LES R2		POMPE FIOUL BFP 21 L3 LES R2 BOMBA BFP 21 L3 LES R2		POMPA BFP 21 L3 LES R2		1
0271	65327118	SPULE 220-230 V NC T85 SPOEL 220-230 V NC T85		BOBINE 220-230 V NC T85 BOBINA 220-230 V NC T85		BOBINA 220-230 V NC T85		1
0272	65325685	PATRONE D16,3X43+O-RING/PUMPE BFP FILTER EN O-RING OLIEPOMP BFP52EL5		CARTOUCHE D16,3X43+O-RING/POMPE BFP CARTUCHO D16,3X43+O-RING /BOMBA BFP		CARTUCCIA D16,3X43+O-RING /POMPA BFP		1
0280	65300242	BRENNERHAUBE GRAU 229X292X181V 1 BRANDERKAP GRAU 229X292X181V 1		CAPOT GRIS 229X292X181V 1 CUBIERTA GRIS 229X292X181V 1		COFANO GRIGIO 229X292X181V 1		1
5001	13016061	DUESE DAN 0,75GPH 45° S NOZZLE DAN 0,75GPH 45° S		GICLEUR DAN 0,75GPH 45° S BOQUILLA DAN 0,75GPH 45° S		UGELLO DAN 0,75GPH 45° S		1
	13016062	DUESE DAN 0,85GPH 45° S NOZZLE DAN 0,85GPH 45° S		GICLEUR DAN 0,85GPH 45° S BOQUILLA DAN 0,85GPH 45° S		UGELLO DAN 0,85GPH 45° S		1
	13016063	DUESE DAN 0,50GPH 45° S SPROEIER DAN 0,50GPH 45° S		GICLEUR DAN 0,50GPH 45° S BOQUILLA DAN 0,50GPH 45° S		UGELLO DAN 0,50GPH 45° S		1
	13016064	DUESE DAN 0,60GPH 45° S NOZZLE DAN 0,60GPH 45° S		GICLEUR DAN 0,60GPH 45° S BOQUILLA DAN 0,60GPH 45° S		UGELLO DAN 0,60GPH 45° S		1
	13016068	DUESE DAN 1,50GPH 45° S NOZZLE DAN 1,50GPH 45° S		GICLEUR DAN 1,50GPH 45° S BOQUILLA DAN 1,50GPH 45° S		UGELLO DAN 1,50GPH 45° S		1
	13016070	DUESE DAN 1,00GPH 45° S NOZZLE DAN 1,00GPH 45° S		GICLEUR DAN 1,00GPH 45° S BOQUILLA DAN 1,00GPH 45° S		UGELLO DAN 1,00GPH 45° S		1
	13018346	DUESE DAN 0,40GPH 45° S NOZZLE DAN 0,40GPH 45° S		GICLEUR DAN 0,40GPH 45° S BOQUILLA DAN 0,40GPH 45° S		UGELLO DAN 0,40GPH 45° S		1
	13018576	DUESE DAN 0,55GPH 45° S SPROEIER DAN 0,55GPH 45° S		GICLEUR DAN 0,55GPH 45° S BOQUILLA DAN 0,55GPH 45° S		UGELLO DAN 0,55GPH 45° S		1
5002	13007665	OELSCHLAUCH DN6X1000 3/8-1/4Z (x1) OLIESLANG DN6 L1,00 M (x1)		FLEXIBLE DN6 LG.1,00 M (x1) LATIGUILLO DN6 LG.1,00 M (x1)		FLESSIBILE DN6 LG.1,00 M (x1)		1
5010	13018482	OELFILTER G3/8-75µ+WINKELANSCHLUSS OLIEFILTER G3/8-75µ+AANSLUITING		FILTRE FIOUL G3/8-75µ+RACCORD FILTRO OIL G3/8-75µ+RACOR		FILTRO OLIO G3/8-75µ+RACCORDO		1
5011	13018478	O-RING D54,5X3/FILTER NBR O-RING D54,5X3/FILTER NBR		O-RING D54,5X3/FILTRE NBR O-RING D54,5X3/FILTRO NBR		O-RING D54,5X3/FILTRO NBR		1
5012	13018479	FILTERTASSE D61X81 ND TRANSPARENT OLIEFILTER KELK D61X81 ND6		GODET DE FILTRE FIOUL D61X81 ND6 TAZA DEL FILTRO GASOLEO D61X81 ND6		TAZZA DEL FILTRO GASOLIO D61X81 ND6		1
5013	13018480	FILTEREINSATZ D36X73 SIKU 50-75MY FILTERELEMENT SIKU 50-75 µM		CARTOUCHE FILTRE SIKU 50-75 µM FILTRO GASOLEO DE CARTUCHO SIKU 50-75 µM		FILTRO A CARTUCCIA GASOLIO SIKU 50-75 µM		1

		RU TR	PT	PL	X
0010	13018849	ПРИНАДЛЕЖНОСТИ КОТЛА D90 EUROBRIDE KAZAN AKSESUARLARI D90 EUROFLANŞI	ACESSORIO CALDEIRA D90 EUROFLANGE	AKCESORIA DO KOTŁA D90 EUROKOŁNIERZ	1
	13022754	ПРИНАДЛЕЖНОСТИ КОТЛА D80 EUROBRIDE KAZAN AKSESUARLARI D80 EUROFLANŞI	ACESSORIO CALDEIRA D80 EUROFLANGE	AKCESORIA DO KOTŁA D80 EUROKOŁNIERZ	1
0011	13010501	ПРОКЛАДКА/ФЛАНЕЦ ГОРЕЛКИ 156X156X6 D80 CONTASI/BRULOR FLANŞI 156X156X6 D80	GAXETA/FLANGE QUEIMADOR 156X156X6 D80	USZCZELKA/KOŁNIERZ PALNIKA 156X156X6 D80	1
	13010502	ПРОКЛАДКА/ФЛАНЕЦ ГОРЕЛКИ 156X156X5 D90 CONTASI/BRULOR FLANŞI 156X156X5 D90	GAXETA/FLANGE QUEIMADOR 156X156X5 D90	USZCZELKA/KOŁNIERZ PALNIKA 156X156X5 D90	1
0012	13011148	ПРОКЛАДКА/ПЛЕТЕНАЯ D80X5X5-267 CONTASIOERÜLÜ D80X5X5-267	GAXETA/TRANÇADA D80X5X5-267	USZCZELKA/PLECIONA D80X5X5-267	1
	13011149	ПРОКЛАДКА/ПЛЕТЕНАЯ D90X5X5-298 CONTASIOERÜLÜ D90X5X5-298	GAXETA/TRANÇADA D90X5X5-298	USZCZELKA/PLECIONA D90X5X5-298	1
0020	13010099	СОПЛО ГОРЕЛКИ D80/54 L183 BRÜLÖR BORUSU D80/54 L183	TUBO DO QUEIMADOR D80/54 L183	RURA PALNIKA D80/54 L183	1
	13011142	СОПЛО ГОРЕЛКИ D90/64,5/60 L198 BRÜLÖR BORUSU D90/64,5/60 L198	TUBO DO QUEIMADOR D90/64,5/60 L198	RURA PALNIKA D90/64,5/60 L198	1
	13012815	СОПЛО ГОРЕЛКИ D80/57 L183 BRÜLÖR BORUSU D80/57 L183	TUBO DO QUEIMADOR D80/57 L183	RURA PALNIKA D80/57 L183	1
0021	13006487	ПЕРЕДНИЙ НАКОНЕЧНИК D79 L50 FP617 ÖN UÇ D79 L50 FP617	COPA DO COMBUSTION D79 L50 FP617	NASADKA PRZEDNIA D79 L50 FP617	1
	13015244	ПЕРЕДНИЙ НАКОНЕЧНИК D84,5 L50 ÖN UÇ D84,5 L50	COPA DO COMBUSTION D84,5 L50	NASADKA PRZEDNIA D84,5 L50	1
0030	13018434	ВОЗДУШНАЯ КАМЕРА 218X135X45 HAVA KUTUSU 218X135X45	CAIXA DE AR 218X135X45	KOMORA POWIETRZA 218X135X45	1
	65300231	ВОЗДУШНАЯ КАМЕРА 218X134+ ИЗОЛЯЦИЯ HAVA KUTUSU 218X134+ YALITIM	CAIXA DE AR 218X134+ ISOLAMENTO	KOMORA POWIETRZA 218X134+ IZOLACJA	1
0035	65300460	КОРПУС 227X224X45 D80 NC4-6H/VL1.40-55 KARTER 227X224X45 D80 NC4-6H/VL1.40-55	CARÇAÇA 227X224X45 D80 NC4-6H/VL1.40-55	OBUDOWA 227X224X45 D80 NC4-6H/VL1.40-55	1
	65327970	КОРПУС 227X224X68 D90 NC9-10H/VL1.95-105 KARTER 227X224X68 D90 NC9-10H/VL1.95-105	CARÇAÇA 227X224X68 D90 NC9-10H/VL1.95	OBUDOWA 227X224X68 D90 NC9H/VL1.95-105	1
0040	13010511	ЗАСЛОНКА РЕЦИ.ВОЗ. D103/35 80X68 L39 108° HAVA GERİ DONUŞUMU D103/35 80X68L39 108°	RECICLAGEM AR D103/35 ALE.80X68 L39 108°	RECYRKULACJA POW.D103/35 80X68 L39 108°	1
	13010512	ЗАСЛОНКА РЕЦИ.ВОЗ. D103/35 100X95 L39 108° HAVAGERİ DONUŞUMU D103/35 100X95L39 108°	RECICLAGEM AR D103/35 100X95 L39 108°	RECYRKULACJA POW.D103/35 100X95 L39 108°	1
	13010513	ЗАСЛОНКА РЕЦИ.ВОЗ. D103/45 100X97 L55 65° HAVA GERİ DONUŞUMU	RECICLAGEM AR D103/45 100X97 L55 65°	RECYRKULACJA POW.D103/45 100X97 L55 65°	1
0050	13010472	КОРОБ РЕГУЛ.КЛАПАНА+ ТРУБ.ФОТОР. /ДИЗ. KUTU KAR.TERTIB.AYARL.+TUPLU HÜCRE/YAKIT	CAIXA COMANDO CONJ. ABA+TUBO CELULA/FUEL	OKNO REGUL.MONT.KLAP+ORUZ.FOTOKOM./OLEJU	1
0060	13009663	ТРАНСФО РОЗЖИГА EBI 2X7,5 230V ATEŞLEME TRAFO. EBI 2X7,5 230V	TRANSFO IGNIÇÃO EBI 2X7,5 230V	TRANSFO ZAPŁONOWY EBI 2X7,5 230V	1
0065	13020416	ПЛИТА ДВИГАТЕЛЬ 275X222X23 D99+O-RING MOTORU PLAKA 275X222X23 D99+O-RING	CHAPA MOTOR 275X222X23 D99+O-RING	PLYTA SILNIK 275X222X23 D99+O-RING	1
0070	13010523	РОЗЕТКА WIELAND 7P SCREENPRINTED PRIZ WIELAND 7P SCREENPRINTED	TOMADA WIELAND 7P SERIGRAFIADO	WTYCZKA WIELAND 7P SITODRUK	1
0080	65300269	БЛОК УПРАВЛЕНИЯ TCH 141.03 KUTU TCH 141.03	PROGRAMADOR TCH 141.03	MODUŁ TCH 141.03	1
	65326871	БЛОК УПРАВЛЕНИЯ TCH 151.12 KUTU TCH 151.12	PROGRAMADOR TCH 151.12	MODUŁ TCH 151.12	1
0105	65326635	ФОТОРЕЗИСТОР QRB1A LG.220+RAST5 HÜCRE QRB1A LG.220+RAST5	CELULA QRB1A LG.220+RAST5	FOTOKOMÓRKA QRB1A LG.220+RAST5	1
	65328028	ФОТОРЕЗИСТОР FTEB3 L255+RAST5 HÜCRE FTEB3 L255+RAST5	CELULA FTEB3 L255+RAST5	FOTOKOMÓRKA FTEB3 L255+RAST5	1
0110	65300335	КАБЕЛЬ ТРАНСФО РОЗЖИГА+PL.3P/RAST3P L250 KABLOSU ATEŞL. TRAFO.+PLUG3P/RAST3P L250	CABO TRANSFO IGNIÇÃO+TOM.3P/RAST3P L250	PRZEWÓD TRANSFO ZAPŁ.+PLUG3P/RAST3P L250	1
0120	13012675	КАБЕЛЬ ЭЛЕКТРОКЛАПАН+ШТ.3P/RAST3P L300V1 KABLOSU ELECTROVANA+FIŞ 3P/RAST3P L300V1	CABO EL.VALVULA+TOMADA 3P/RAST3P L300V1	PRZEWÓD EL.ZAWOR+WTYCZK.3P/RAST3P L300V1	1
0130	13010519	КАБЕЛЬ ЭЛЕКТРОДВИГАТЕЛЬ+P.3P/RAST3P L300 MOTORU KABLOSU+FIŞ 3P/RAST3P L300	CABO MOTOR+TOMADA 3P/RAST3P L300	PRZEWÓD SILNIK+WTYCZKA 3P/RAST3P L300	1
0140	13011126	КАБЕЛЬ ПОДОГРЕВ. DAN+P.4P/RAST4P L450 ISITICI KABLOSU DAN+PLUG4P/RAST4P L450	CABO PREAQUECEDOR DAN+TOM.4P/RAST4P L450	PRZEWÓD PODGRZEW. DAN+PLUG4P/RAST4P L450	1
0150	13006486	ДЕФЛЕКТОР D55/17 4SL R DEFLEKTOR D55/17 4SL R	DEFLECTOR D55/17 4SL R	DEFLEKTOR D55/17 4SL R	1
	13012730	ДЕФЛЕКТОР D63/18 6SL R DEFLEKTOR D63/18 6SL R	DEFLECTOR D63/18 6SL R	DEFLEKTOR D63/18 6SL R	1
0160	13012680	ЛИНИЯ ФОРСУН. D8 L252 M8 ПОДОГР. FPHE 5-LE PÜSK.M.HATTI D8 L252M8 ISITICI FPHE 5-LE	LÍNEA BOQU. D8 L252 M8 AQUEC. FPHE 5-LE	UKŁAD DYSZY D8 L252 M8 PODGR. FPHE 5-LE	1
	13018521	ЛИНИЯ ФОРСУНКИ D8 L272 M8 FPB-LE PÜSKÜRTME MEM.HATTI D8 L272 M8 FPB-LE	LÍNEA DE BOQUILLA D8 L272 M8 FPB-LE	UKŁAD DYSZY D8 L272 M8 FPB-LE	1
	13018567	ЛИНИЯ ФОРСУНКИ D8 L252 M8 FPB-LE PÜSKÜRTME MEM.HATTI D8 L252 M8 FPB-LE	LÍNEA DE BOQUILLA D8 L252 M8 FPB-LE	UKŁAD DYSZY D8 L252 M8 FPB-LE	1
0161	11002536	ФОРСУНКА DAN 0,45GPH 45° HFD PÜSK. MEMESI DAN 0,45GPH 45° HFD	BOQUILLA DAN 0,45GPH 45° HFD	DYSZA DAN 0,45GPH 45° HFD	1

		<table border="1"><tr><td>RU</td></tr><tr><td>TR</td></tr></table>	RU	TR	<table border="1"><tr><td>PT</td></tr><tr><td></td></tr></table>	PT		<table border="1"><tr><td>PL</td></tr><tr><td></td></tr></table>	PL		
RU											
TR											
PT											
PL											
	13016061	ФОРСУНКА DAN 0,75GPH 45° S PÜSK. MEMESI DAN 0,75GPH 45° S	BOQUILLA DAN 0,75GPH 45° S	DYSZA DAN 0,75GPH 45° S	1						
	13016064	ФОРСУНКА DAN 0,60GPH 45° S PÜSK. MEMESI DAN 0,60GPH 45° S	BOQUILLA DAN 0,60GPH 45° S	DYSZA DAN 0,60GPH 45° S	1						
	13018576	ФОРСУНКА DAN 0,55GPH 45° S PÜSK. MEMESI DAN 0,55GPH 45° S	BOQUILLA DAN 0,55GPH 45° S	DYSZA DAN 0,55GPH 45° S	1						
	65300496	ФОРСУНКА DAN 0,45GPH 45° S PÜSK. MEMESI DAN 0,45GPH 45° S	BOQUILLA DAN 0,45GPH 45° S	DYSZA DAN 0,45GPH 45° S	1						
	65323348	ФОРСУНКА DAN 1,10GPH 45° H PÜSK. MEMESI DAN 1,10GPH 45° H	BOQUILLA DAN 1,10GPH 45° H	DYSZA DAN 1,10GPH 45° H	10						
0170	13018403	УПОРНОЕ КОЛЬЦО D25/19X3/ФОРСУ.-ДЕФЛЕКТОР BAKI BILEZİĞİ D25/19X3/PÜSK.-DEFLEKT.	ANEL DE BATEENTE D25/19X3/BOQU.-DEFLECT.	PIERŚCIEŃ D25/19X3/DISZA-DEFLEKT.	1						
0180	13011138	ФЛАНЕЦ 22X20X7 FIX. ЭЛЕКТРОД FLANŞI 22X20X7 FIX. ELEKTROD	FLANGE 22X20X7 FIX. ELETRODO	KOŁNIERZ 22X20X7 FIX. ELEKTRODA	1						
0190	65300270	БЛОК ЭЛЕКТРОДОВ 25X46 d4D1,5X21 56° ELEKTROD BLOĞU 25X46 d4D1,5X21 56°	BLOCO ELETRODO 25X46 d4D1,5X21 56°	BLOK ELEKTROD 25X46 d4D1,5X21 56°	1						
0200	13011123	КАБЕЛЬ РОЗЖИГА/D4 L270X2 + ВОРОНКА ATEŞLEME KABLOSU D4/D4 L270X2+KAB.KANALI	CABO ENCENDIDO D4/D4 L270X2 + FUNIL	PRZEWÓD ALU. D4/D4 L270X2 + PRZELOTKA	1						
0210	13010100	ГРАДУИРОВАННАЯ ЛИНЕЙКА 0 - 20 L70,5 DERECELI CETVEL 0 - 20 L70,5	REGUA GRADUADA 0 - 20 L70,5	LINIAŁ Z PODZIAŁKĄ 0 - 20 L70,5	1						
0220	13010101	РАБОЧЕЕ КОЛЕСО D.133X42 D10 TURBIN D133X42 D10	TURBINA D133X42 D10	WIMIK D133X42 D10	1						
	13010517	РАБОЧЕЕ КОЛЕСО D.133X62 D10 TURBIN D133X62 D10	TURBINA D133X62 D10	WIMIK D133X62 D10	1						
0230	12002251	ШЛАНГ L 1500 DN6 G3/8G1/4A ESNEK DN6 L1,5M (X1)	FLEXIVEL L 1500 DN6 G3/8G1/4A	PRZEWÓD GIĘTKI DN6 L1,5M (X1)	1						
0240	13021624	ТРУБКА НАСОС/ЛИНИЯ ФОРСУНКИ POMPA BORUSU/PÜSKÜRTME MEMESI HATTI	TUBO BOMBA/LÍNEA DE BOQUILLA	PRZEWÓD POMPA/UKŁAD DYSZY	1						
0250	65326746	ЭЛЕКТРОДВИГАТЕЛЬ 0,11KW 230V D10 MOTORU 0,11KW 230V D10	MOTOR 0,11KW 230V D10	SILNIK 0,11KW 230V D10	1						
0251	13010016	КОНДЕНСАТОР 6,3µF 2P 3mm KONDENSATOR 6,3µF 2P 3MM	CAPACITOR 6,3µF 2P 3mm	KONDENSATOR 6,3µF 2P 3MM	1						
	13011117	КОНДЕНСАТОР 4µF 2P 3mm KONDENSATOR 4µF 2P 3MM	CAPACITOR 4µF 2P 3mm	KONDENSATOR 4µF 2P 3MM	1						
	65326737	КОНДЕНСАТОР 5µF 475V B P2 30X57 KONDENSATOR 5µF 475V B P2 30X57	CAPACITOR 5µF 475V B P2 30X57	KONDENSATOR 5µF 475V B P2 30X57	1						
0260	65074172	СЦЕПЛЕНИЕ D18/14,7/11X22НАСОС/ЭЛЕКТРОДВ. KARLİN D18/14,7/11X22 POMPA/MOTORU	ACOPLAMENTO D18/14,7/11X22 BOMBA/MOTOR	ŁĄCZNIK D18/14,7/11X22 POMPA /SILNIK	1						
0270	13022753	НАСОС BFP 21 L3 LES R2 POMPA BFP 21 L3 LES R2	BOMBA BFP 21 L3 LES R2	POMPA BFP 21 L3 LES R2	1						
0271	65327118	ОБМОТКА 220-230 V NC T85 BOBIN 220-230 V NC T85	BOBINA 220-230 V NC T85	CEWKA 220-230 V NC T85	1						
0272	65325685	КАРТРИДЖ D16,3X43+O-RING/НАСОС BFP KARTUŞD16,3X43+O-RING/POMPA BFP	CARTUCHO D16,3X43+O-RING /BOMBA BFP	NABÓJ D16,3X43+O-RING/POMPA BFP	1						
0280	65300242	КОЖУХ СЕРЫЙ 229X292X181/V 1 KAPAĞI GRI 229X292X181/V 1	COBERTURA CINZA 229X292X181/V 1	OSŁONA SZARY 229X292X181/V 1	1						
5001	13016061	ФОРСУНКА DAN 0,75GPH 45° S PÜSK. MEMESI DAN 0,75GPH 45° S	BOQUILLA DAN 0,75GPH 45° S	DYSZA DAN 0,75GPH 45° S	1						
	13016062	ФОРСУНКА DAN 0,85GPH 45° S PÜSK. MEMESI DAN 0,85GPH 45° S	BOQUILLA DAN 0,85GPH 45° S	DYSZA DAN 0,85GPH 45° S	1						
	13016063	ФОРСУНКА DAN 0,50GPH 45° S PÜSK. MEMESI DAN 0,50GPH 45° S	BOQUILLA DAN 0,50GPH 45° S	DYSZA DAN 0,50GPH 45° S	1						
	13016064	ФОРСУНКА DAN 0,60GPH 45° S PÜSK. MEMESI DAN 0,60GPH 45° S	BOQUILLA DAN 0,60GPH 45° S	DYSZA DAN 0,60GPH 45° S	1						
	13016068	ФОРСУНКА DAN 1,50GPH 45° S PÜSK. MEMESI DAN 1,50GPH 45° S	BOQUILLA DAN 1,50GPH 45° S	DYSZA DAN 1,50GPH 45° S	1						
	13016070	ФОРСУНКА DAN 1,00GPH 45° S PÜSK. MEMESI DAN 1,00GPH 45° S	BOQUILLA DAN 1,00GPH 45° S	DYSZA DAN 1,00GPH 45° S	1						
	13018346	ФОРСУНКА DAN 0,40GPH 45° S PÜSK. MEMESI DAN 0,40GPH 45° S	BOQUILLA DAN 0,40GPH 45° S	DYSZA DAN 0,40GPH 45° S	1						
	13018576	ФОРСУНКА DAN 0,55GPH 45° S PÜSK. MEMESI DAN 0,55GPH 45° S	BOQUILLA DAN 0,55GPH 45° S	DYSZA DAN 0,55GPH 45° S	1						
5002	13007665	ШЛАНГ DN6 LG.1,00 M (x1) ESNEK DN6 LG.1,00 M (x1)	FLEXIVEL DN6 L1,00 M (X1)	PRZEWÓD GIĘTKI DN6 LG.1,00 M (x1)	1						
5010	13018482	ФИЛЬТР ТОПЛИВА G3/8-75µ+ШТУЦЕР FILTRE OIL G3/8-75µ+RAKOR	FILTRO OIL G3/8-75µ+UNIÃO	FILTR OIL G3/8-75µ+ZŁĄCZE	1						
5011	13018478	О-КОЛЬЦО D54,5X3/ФИЛЬТР NBR O-RING D54,5X3/FILTRE NBR	O-RING D54,5X3/FILTRO NBR	O-RING D54,5X3/FILTR NBR	1						
5012	13018479	КОРПУС ФИЛЬТРА D61X81 ND6 FILTRE KAVANOZU D61X81 ND6	COPO DO FILTRO GASOLEO D61X81 ND6	MISKA FILTRA D61X81 ND6	1						
5013	13018480	ФИЛЬТР МАСЛЯНЫЙ КАРТРИДЖ SIKU 50-75 µM YAĞ FILTRESİ KARTUŞU SIKU 50-75 µM	FILTRO GASOLEO A CARTUCHO SIKU 50-75 µM	WKŁAD FILTRA OLEJU SIKU 50-75 µM	1						

